

VHF RADIO (DSC Class D)

NVR-2000

- Meet the latest ITU standards
- 4-digital channels available
- Dual watch function
- Type approval with CCS



- NVR-2000 VHF RADIO is a high performance VHF device, capable of voice communication and DSC (digital selective calling) facilities as well.
- Conforming to Class D standard set for VHF DSC by ITU and IMO regulation, NVR-2000 conforms to the regulations of ITU Regulation Appendix 18, ITU-R M.493-16, IMO MSC.1/Circ.1460/Rev.4, IEC 61097-7, IEC 61097-3, etc.



SPECIFICATIONS

- TX Frequency: 156.025 ~ 157.425 MHz
- RX Frequency: 156.050 ~ 163.275 MHz
- Working Channel: Full ITU channels
- DSC Watch CH: CH70
- TX Power: 25 W (high) / 1 W (low)
- RX Sensitivity: $\leq 2 \mu V$ (SINAD=20 dB)
- Interface:
 - GNSS Input: RS422, 4800bps
 - Print I/O: RS232, 4800bps
- Power Supply: DC 13.8 V (range 12V~15V), max 5.5 A
- Size: 137 (H)×233 (W)×91 (D) mm
- Weight: 1.3 kg
- Operating Temperature:
 - 15° ~ 55°C (Transceiver, Microphone)
 - 40° ~ 55°C (Antenna)
- IP Grade:
 - IP22: Transceiver, Microphone
 - IP66: Antenna

EQUIPMENT LIST

● STANDARD

- | | | |
|---------------|----------|-------|
| - Transceiver | NVR-2000 | 1 pc |
| - Microphone | NHS-102 | 1 pc |
| - Accessories | | 1 set |

● OPTIONS

- | | | |
|-----------------------|---------|------|
| - AC/DC PSU | PS-10B | 1 pc |
| - VHF Antenna | NVA100 | 1 pc |
| - External Speaker | NSK-100 | 1 pc |
| - Flush Mount Bracket | | 1 pc |

SIZE DIMENSION

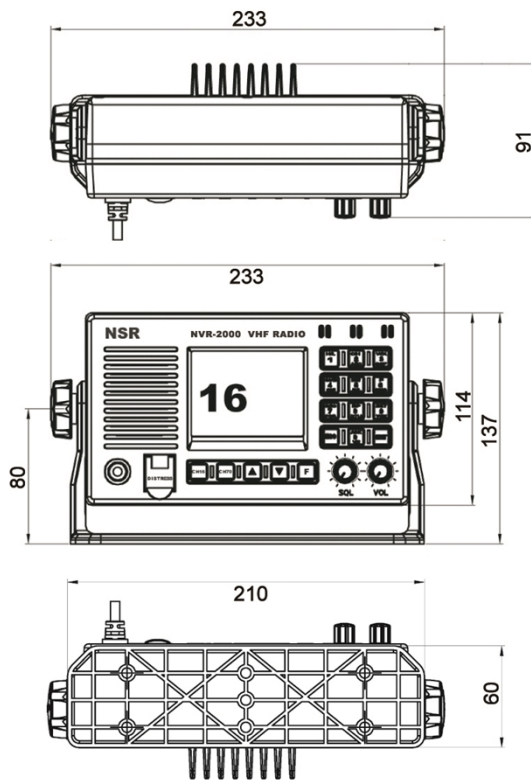

SYSTEM DIAGRAM

NVA100 VHF ANTENNA (OPTION)

