

THD (GNSS Method)/GNSS COMPASS

NGC-3000

- Determine the heading of a ship
- Highly accurate heading of 0.4° RMS
- Full GNSS with GPS, BDS, GLONASS, GALILEO
- Both THD (transmitting heading device) and GNSS
- Large LCD, 7 inch/color, touch screen operation
- Highly accurate SOG, COG, ROT and position
- Multi outputs of RS422 & LAN
- Data interface to BAM/INS
- Up to five display modes available
- Compliant with IMO MSC.116 (73) for THD
- Maintenance-free design
- Type approval with CCS



PROCESSOR UNIT



DISPLAY UNIT

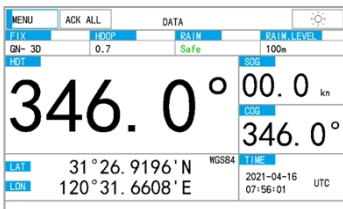

DATA (NAV DATA)

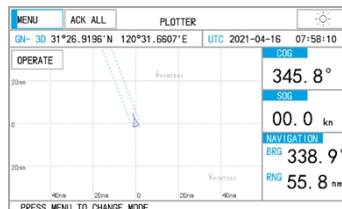

PLOTTER

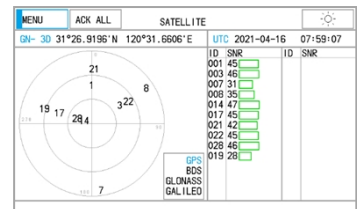

SATELLITE

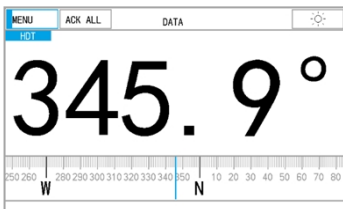

DATA (HEADING)

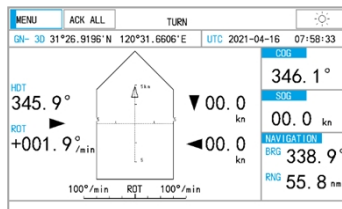

TURN

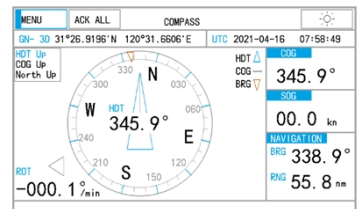

COMPASS



SPECIFICATIONS

● GENERAL

- Heading Accuracy: 0.4° RMS
- Heading Resolution: 0.1°
- Tracking Rate of Turn: 45°/sec
- Tracking Acceleration: 1G
- Pitch/roll Angle: ±60°
- Receiving Frequencies: GPS L1/L2, BDS B1/B2, GLONASS L1/L2, GALILEO E1/E5b
- Position Accuracy: 1.5 m
- Speed Accuracy: 0.03 m/s
- Position Fixing Time: <30 s
- Data Output Rate: max 50 Hz

● DISPLAY

- Display System: 7 inch, color LCD, touch screen operation, 154 (W)×87 (H) mm
- Resolution: 800×480 dots
- Display Mode: DATA (Heading, NAV data), PLOTTER, TURN, COMPASS, SATELLITE

● INTERFACE

- Output Ports: 3 IEC-61162-1 Ed4, Ed5, NMEA 1.5, 2.0, 2.3
- Transmission Speed: 4800/9600/19200/38400 bps (selectable)
- BAM/INS In/Out: ACN, ALC, ALF, HBT
- Data Sentences: HDT, THS, ROT, HDG, HDM, HRC, HRM, RMC, VTG, ZDA, GLL, GGA, DTM, GNS, RTE, WPL, RMB, BOD, APB

- **POWER SUPPLY:** DC 24 V (range 12~36 V), 500 mA

- **DIMENSION:** 174 (W)×81 (H)×160 (D) mm (Processor Unit)
264 (W)×145 (H)×83 (D) mm (Display Unit)
808.2 (W)×240.1 (H)×244.4 (D) mm (Antenna Unit)

● ENVIRONMENTAL CONDITION

- Temperature Range: -20°C~+55°C operating
-30°C~+70°C storage (Antenna Unit)
- Compass Safe Distance: 1.15m (Standard)
- IP Grade: IP22 (Processor Unit & Display Unit)
IP66 (Antenna Unit)

SYSTEM DIAGRAM

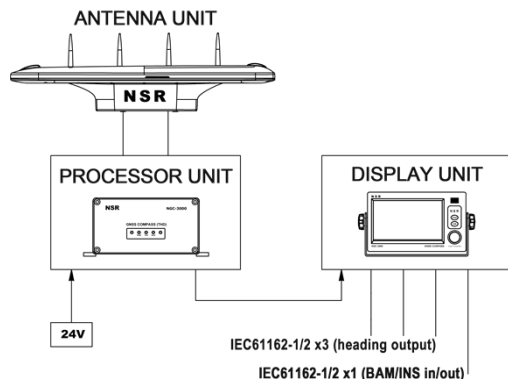

EQUIPMENT LIST

● STANDARD

- Processor Unit NGC-3000P 1 pc
- Display Unit NGC-3000D 1 pc
- Antenna Unit NGC-3000A 1 pc
- Accessories 1 set

● OPTIONS

- Flush Mount Bracket for Display Unit 1 pc

SIZE DIMENSION

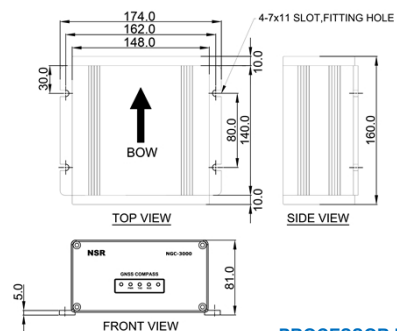

PROCESSOR UNIT

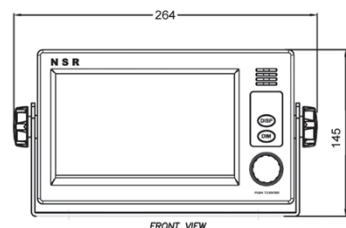

DISPLAY UNIT

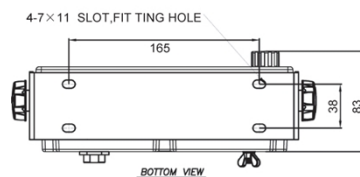

ANTENNA UNIT

